

## ZigBee 3.0 Constant voltage LED Controller



WZS1



WZS2



WZS3



WZS4



WZS5

CE RoHS emc RED

### Features

- Used for control RGB, RGBW, RGB+CCT, color temperature or single color LED strip.
- DC power socket input and 1/2/3/4/5 channel constant voltage output.
- Tuya smart APP cloud control, support color and brightness adjust, delay turn on/off, timer run, scene edit, music play, sleep wake-up and biorhythms function.
- Philips HUE APP control by connect with Philips HUE bridge.
- Voice control, support for Amazon Alexa, Google Assistant, Tmall Genie and Xiaodu voice assistant.
- Can relay and route to each other, up to 15 hops.
- Match with Zigbee 3.0 remote or scene panel control optional.

### Technical Parameters

Input and Output		WZS1	WZS2	WZS3	WZS4	WZS5
Model No.		WZS1	WZS2	WZS3	WZS4	WZS5
Light type		Single color	CCT	RGB	RGBW	RGB+CCT
Output channel number		2	2	3	4	5
Input voltage		12-36VDC	12-36VDC	12-24VDC	12-24VDC	12-24VDC
Input current		10.5A	10.5A	12.5A	12.5A	15.5A
Output voltage		12-36VDC	12-36VDC	12-24VDC	12-24VDC	12-24VDC
Output current		2CH,5A/CH	2CH,5A/CH	3CH,4A/CH	4CH,3A/CH	5CH,3A/CH
Output power		2x(60-180)W	2x(60-180)W	3x(48-96)W	4x(36-72)W	5x(36-72)W
PWM Frequency		4KHz	4KHz	2KHz	2KHz	2KHz
Dimming data		Safety and EMC			Package	
Input signal	Zigbee 3.0	EMC standard (EMC)	ETSI EN 301 489-1 V2.2.3 ETSI EN 301 489-17 V3.2.4		Size	L120 x W43 x H27mm
Control distance	30m (Barrier-free space)	Safety standard	EN 61348-1:2015+A1:2021 EN 61348-2-13:2014+A1:2017		Gross weight	0.074kg
Dimming gray scale	65536 (2 <sup>16</sup> ) levels	Radio Equipment(RED)	ETSI EN 300 328 V2.2.2		Environment	
Dimming range	0-100%	Certification	CE,EMC,RED		Operation temperature	T <sub>a</sub> : -30 °C ~ +55 °C
Dimming curve	Logarithmic	Warranty			Case temperature (Max.)	T <sub>c</sub> : +85 °C
		Warranty	5 years		IP rating	IP20

### Mechanical Structures and Installations

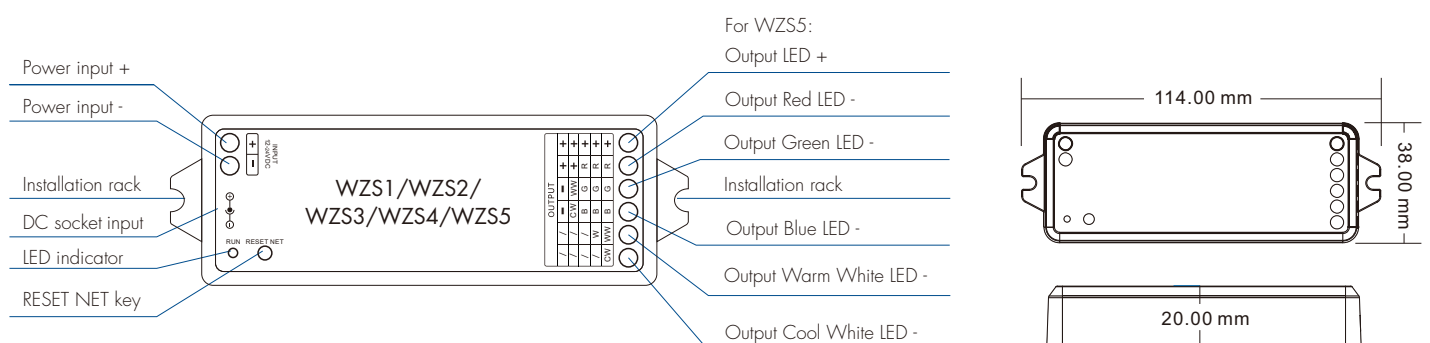

## System wiring

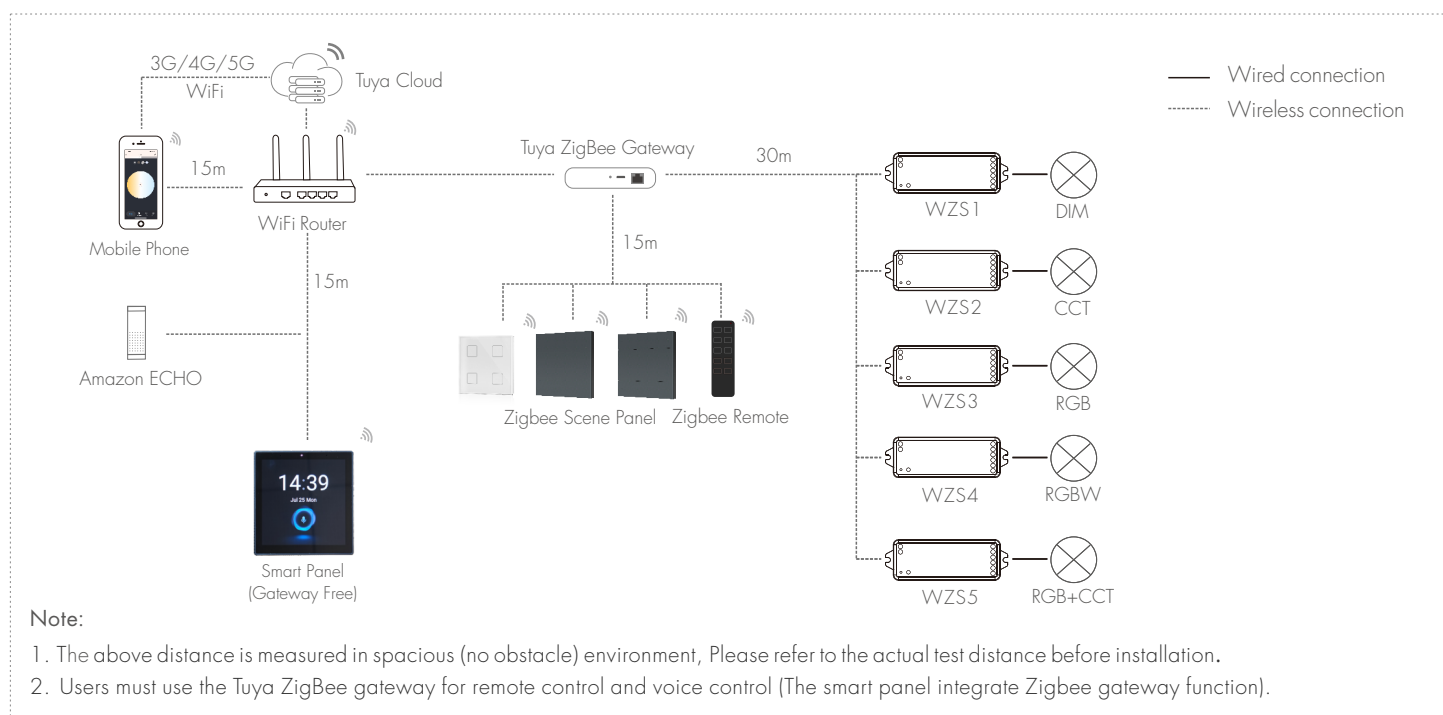

## App Operating Instructions

### 1. Network pairing

- Download the Tuya smart APP and register an account, search and add the Tuya Zigbee gateway device.
- Quickly press the "RESET NET" button five times or repeat power on and off five times to clear the previous network connection, enter pairing mode with the output light breathes blinking.
- Under the gateway, search and add new device.  
If the network connection is successful, you can find ZBS-DIM, ZBS-CCT, ZBS-RGB, ZBS-RGBW or ZBS-RGB+CCT devices in Tuya smart APP.

### 2. Lighting control settings and wiring diagram

After pairing the light device, click the device and change brightness and color by touch brightness slide and color wheel.

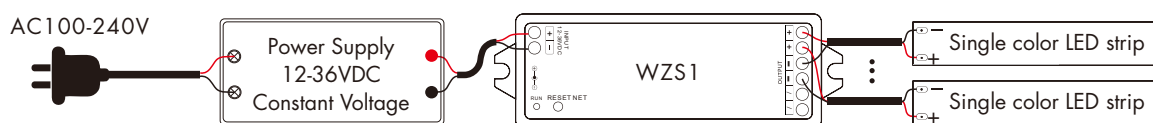

**Dimming:**  
Touch brightness slide to adjust brightness.

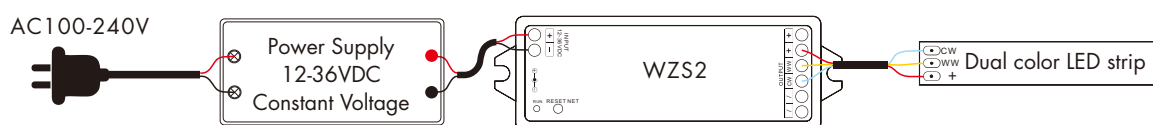

**CCT dimming:**  
Touch color wheel to adjust color temperature.  
Touch brightness slide to adjust brightness.  
Up to 8 color shortcuts can be defined.

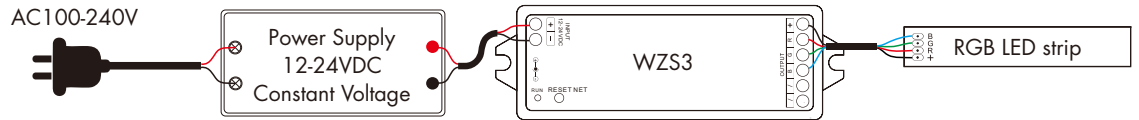
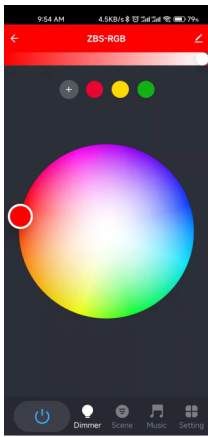

**RGB dimming:**

Touch color wheel to adjust static RGB color.  
 Touch brightness slide to adjust color brightness.  
 Up to 8 color shortcuts can be defined.

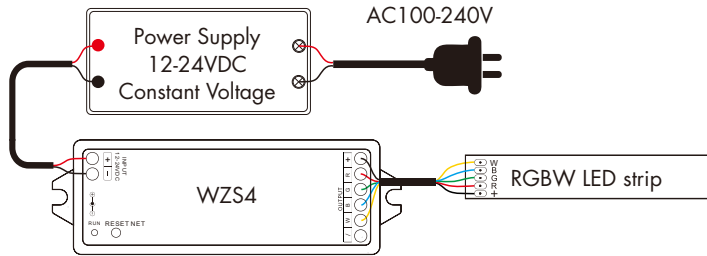
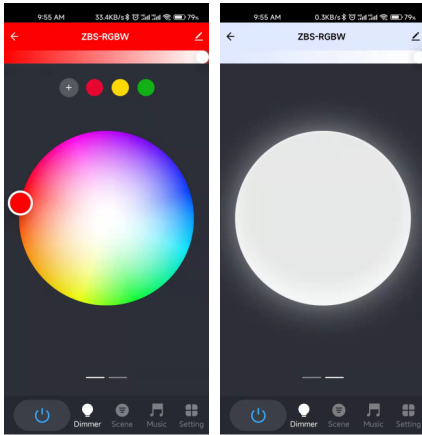

**RGBW dimming :**

Touch color wheel to adjust static RGB color.  
 Touch brightness slide to adjust RGB color brightness or WV brightness.  
 Up to 8 color shortcuts can be defined.

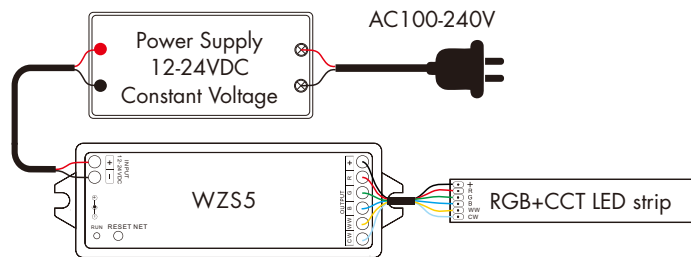
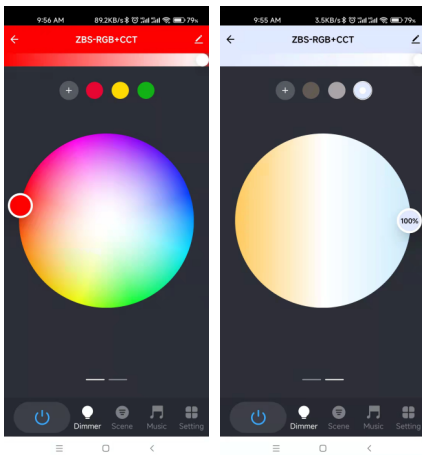

**RGB+CCT dimming :**

Touch color wheel to adjust static RGB color or color temperature.  
 Touch brightness slide to adjust RGB color brightness or CCT brightness.  
 RGB and CCT all have up to 8 color shortcuts can be defined.

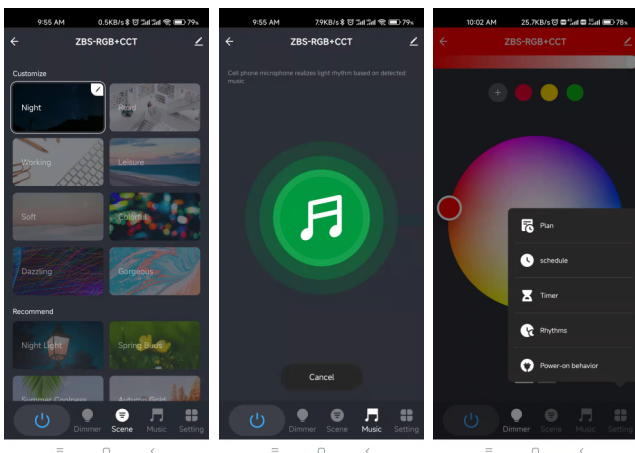

In "Scene", there are 8 scene can be recalled or customized.  
 In "Music", The music play can use smart phone music player or micro-phone as music signal input.  
 In "Setting", there are Plan, Schedule, Timer, Biorhythms, Power-on behavior functions.

## Available Zigbee 3.0 remote and scene panel



R2(WZS)  
CCT remote

Connect the remote, scene panel and LED controllers through the Zigbee gateway on Tuya smart APP firstly. There are 8 scenes in the Tuya smart APP, which can be set to lighting scenes or linkage scenes. Lighting scene is used for the overall control of multiple lamps, like the light adjustment of the entire room. Linkage scene is used for linkage control of different equipment, such lamps and curtains on and off together. After successful scene setting, you can use the remote and scene panel to control these LED controllers directly.

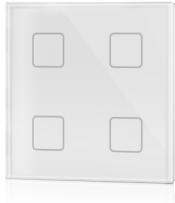

TS4(WZS)  
4 Scene Panel

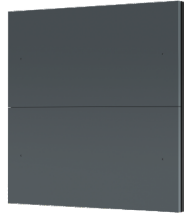

PK4(WZS)  
4 Scene Panel



PK8(WZS)  
8 Scene Panel

## Use of Smart Panel

- Connect the smart panel to WiFi network and open the Tuya smart APP to scan the QR code to binding.
- On the Tuya smart APP, under the smart panel, searching and adding one or more light devices.
- After adding light devices, users can set scene in the Tuya smart APP, and these scenes will be automatically synced to the smart panel.
- After setting successfully, users can control lights by touch color slide and recall scene on the smart panel screen directly .

Main Screen



All Devices



Single color

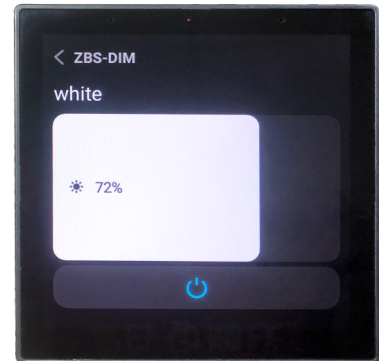

Color temperature interface



RGB/RGBW/RGB+CCT interface

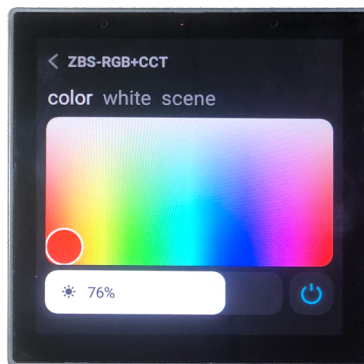

Scene recall interface

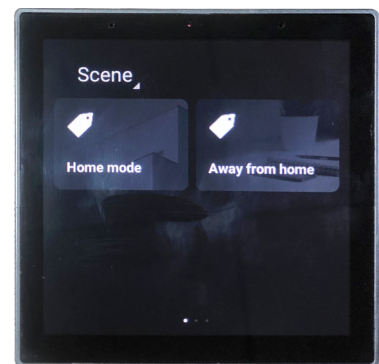

Note:

- 1.The smart panel must use a 2.4GHz band router when connecting wireless networks.
- 2.Smart panel have Zigbee gateway function, no need for external gateway.
- 3.The smart panel connects up to 80 sub devices.