

LTECH

DMX512 DECODER

LT-916

16
CHANNELS

8 bit / 16 bit

3 kinds of DMX interfaces

Short circuit / Over current / Overheat protection



Photoelectric
isolation

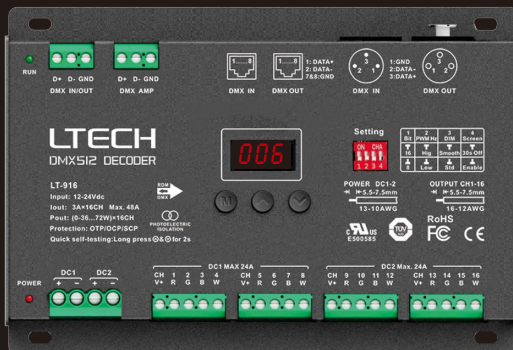

www.ltech-led.com

Product introduction

1. Designed for Hi-power multiple channels application, 16 channels output, and up to 1152W output power.
2. Easy operation with digital display and the touch buttons.
3. 3-pin XLR, RJ45 DMX and green terminal interface with photoelectric isolation, improve signal transmission efficiency and anti-interference ability, the green terminal also has signal amplifier function.
4. With RDM remote management protocol, the operations can be completed via the RDM master console, such as parameters browsing & settings, DMX address settings, equipment recognition, etc.
5. With firmware upgrade function.
6. With short circuit, over current and overheat protection, as well as warning function when a fault occurs.
7. With power-on state management and fast self-testing function.
8. High/low PWM frequency available.
9. 16bit (65536 levels) / 8bit (256 levels) grey level available.



3-pin XLR



RJ45

Photoelectric
isolation

RDM

Short circuit
protectionOverheat
protectionOver current
protection

Technical specs

Model :	LT-916
Input signal :	DMX512/RDM
DMX interfaces :	3-pin XLR, RJ45, green terminal
Input voltage :	12~24Vdc
Current load :	3A × 16CH Max. 48A
Output power :	[0~36W...72W] × 16CH Max. 1152W
Grey level :	8bit (256 levels) / 16bit (65536 levels)
Photoelectric isolation :	Yes
Protection :	Short circuit / Overheat / Over current protection, recover automatically.
Working temperature :	-30°C~65°C
Dimensions :	180×122×39mm(L×W×H)
Package size :	193×127×41mm(L×W×H)
Weight (G.W.) :	730g

Product size

Unit: mm

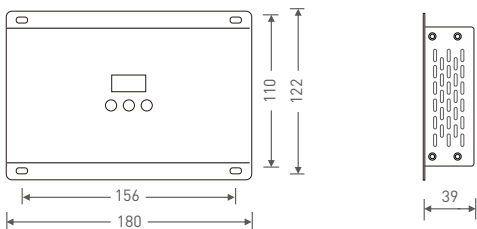

Main component description

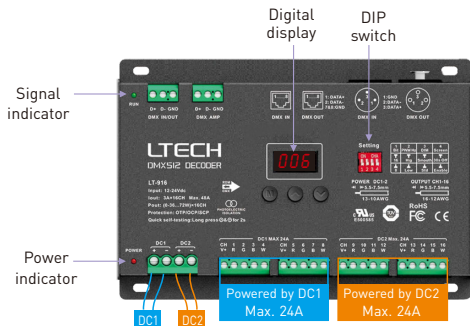

Digital display



- Digital display will enter the locked mode without operating after 15S.
- Long press "M" key to unlock.
- Short press "M" key to switch numbers.
- Press "^" "v" key to adjust value.

DIP switch



1 Bit	2 PWM Hz	3 DIM	4 Screen
16	High	Smooth	30S off
8	Low	Std	Enable

* Press "^" or "v" keys simultaneously for 2-3 seconds, decoder will enter self-testing function.

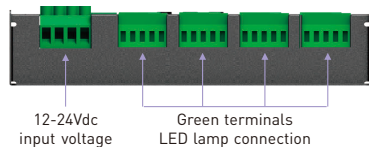
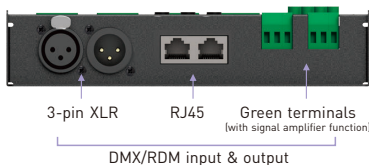

2 Connecting LED lights:

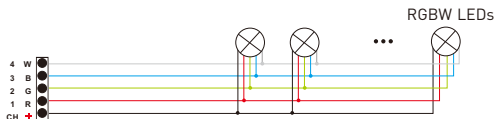
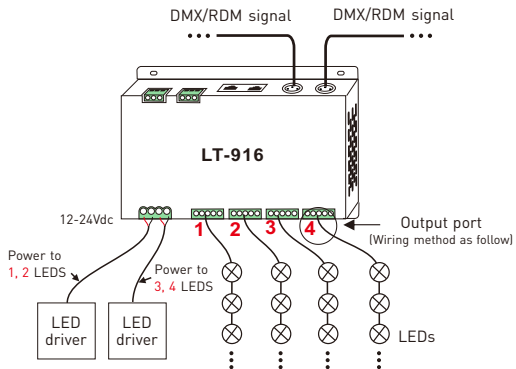
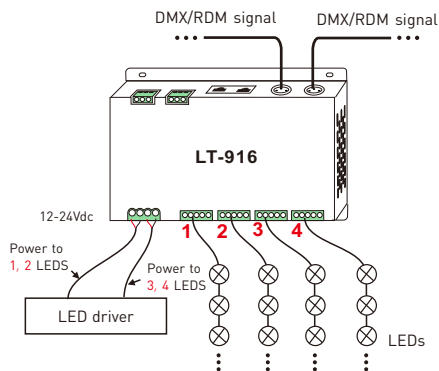

3. The connection diagram of 3 kinds of DMX/RDM terminals:

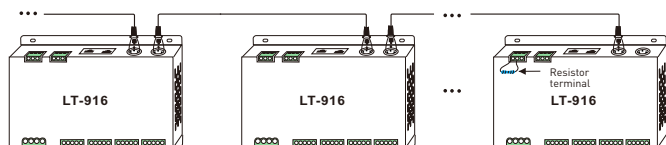

3-pin XLR connected in parallel

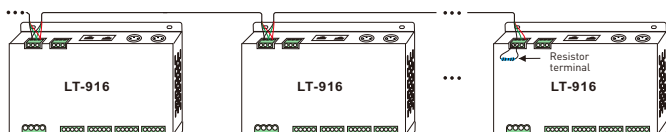

Green terminal connected in parallel

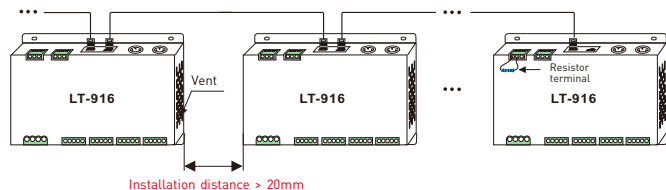

RJ45 connected in parallel

These 3 terminals can be connected in a mixed way.

*** Installation attentions:** please reserve enough ventilation distance between decoders (>20mm), be sure not to block the vent, or it will affect lifetime of decoder for poor heat dissipation.

4. The connection diagram of AMP signal amplifier terminal:

- * Connecting with green terminal or an extra amplifier will be needed when more than 32 decoders are connected or use overlong signal wire(as shown below). Signal amplifier should not be more than 5 times continuously.

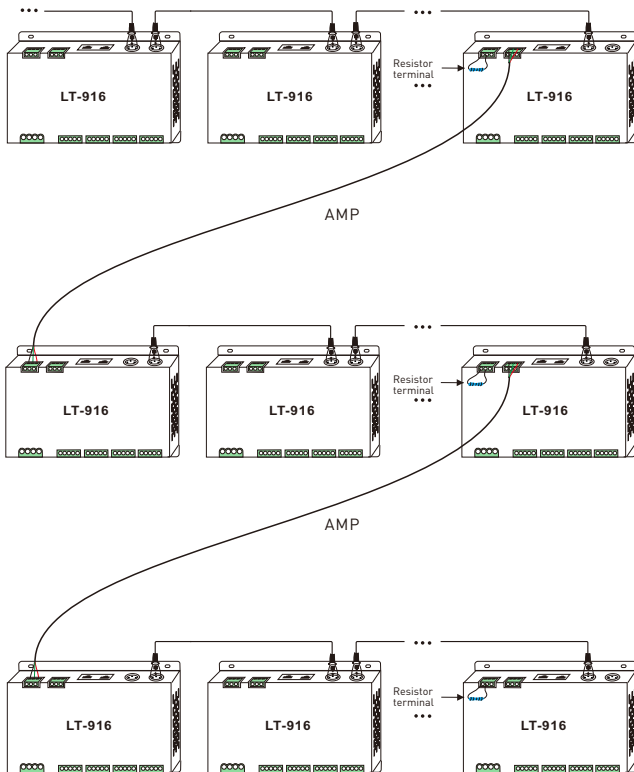

Work with RDM editor

LT-916 can work with LTECH RDM editor (Model: WiFi-RDM01) to realize changing the parameters by long-range setting, wiring diagram as below:

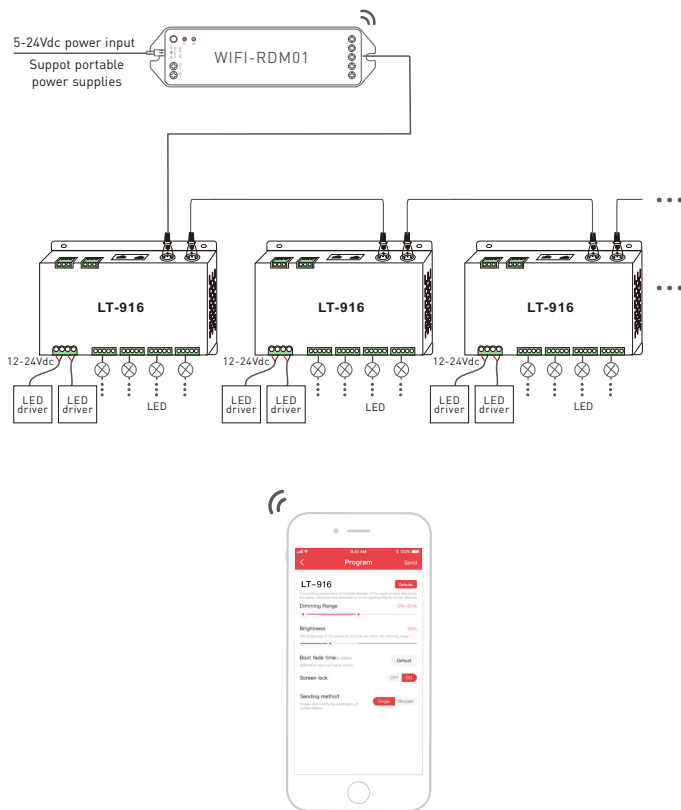

RDM editor App interface instruction

Download the App, setting LT-916 parameters (dimming range, brightness, boot fade time etc.) after well connecting the RDM editor, more details, please check the manual of WiFi-RDM01.

Well installation of products first, then working with WiFi -RDM01 to realize setting parameters and firmware upgrade by App.

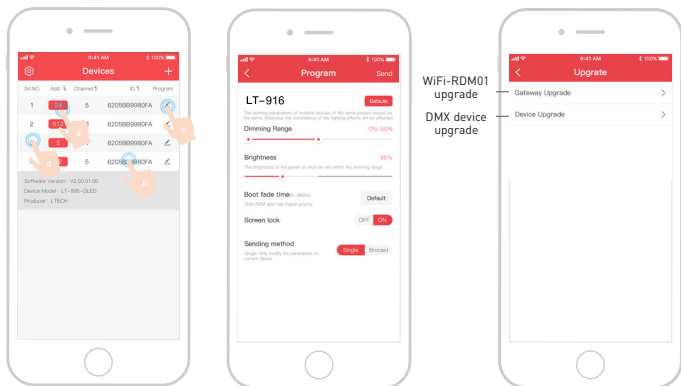

WiFi-RDM01
upgrade
DMX device
upgrade

- a: Click "Add", edit the address in corresponding box.
- b: Click "ID", get more product details.
- c: Click "🔍", enter edited interface.
- d: Click "No.", issue the recognizing command.

Supporting WiFi-RDM01 upgrade
and DMX driver upgrade.

Attentions

1. Products shall be installed by qualified professionals.
 2. LTECH products are non-waterproof (special models excepted). Please avoid the sun and rain. When installed outdoors, please ensure it is mounted in a water proof enclosure.
 3. Good heat dissipation will extend the working life of products. Please ensure good ventilation.
 4. Please check if the working voltage used complies with the parameter requirements of products.
 5. The diameter of wire used must be able to load the light fixtures you connect and ensure the firm wiring.
 6. Before you power on products, please make sure all the wiring is correct in case of incorrect connection that causes damage to light fixtures.
 7. If a fault occurs, please do not attempt to fix products by yourself. If you have any question, please contact your suppliers.
- * This manual is subject to changes without further notice. Product functions depend on the goods. Please feel free to contact our official distributors if you have any question.

Warranty agreement

Warranty periods from the date of delivery : 5 years.

Free repair or replacement services for quality problems are provided within warranty periods.

Warranty exclusions below:

- Beyond warranty periods.
 - Any artificial damage caused by high voltage, overload, or improper operations.
 - Products with severe physical damage.
 - Damage caused by natural disasters and force majeure.
 - Warranty labels and barcodes have been damaged.
 - No any contract signed by LTECH.
1. Repair or replacement provided is the only remedy for customers. LTECH is not liable for any incidental or consequential damage unless it is within the law.
 2. LTECH has the right to amend or adjust the terms of this warranty, and release in written form shall prevail.